

Rules of the Association
Miracle Association Rules of Measurement and Construction



MIRACLE DINGHY

RULES OF MEASUREMENT AND CONSTRUCTION

2024

1. GENERAL

- [a] This is a One Design Class and the object of these rules is to ensure that in exterior Hull form, hull weight, Sail plan and Spars, the boats are nearly alike as possible whilst allowing some latitude in the design of the interior. The hull may be constructed of wood, foam reinforced plastic, glass reinforced plastic or a combination of these. Carbon and aramid fibres may not be used. The said form of construction shall have received the approval of the Committee of the Association and shall comply with any measurement or other condition that may be applied. If the Measurer considers that there has been any attempt to depart from the design in any particular way, he shall record it on the measurement form.
- [b] A boat moulded from the copyright holder's approved mould is adopted by the Association. The Deck (in the case of the Composite/FRP Hull), the Spars, Foils and Sails need measuring. Measurements 30-45 need not be taken for a new Composite boat. Measurements 4-21 and 30-45 need not be taken for a new FRP Boat.
- [c] Boats, particularly the external hull shape, must conform to the original Jack Holt Design as depicted in Diagrams 1 and 2 and defined in the plans as held by the Association

the following variations are allowed:

*

Remodelled bulkheads , centreboard case and decks plus a half height, full length front buoyancy tank all as detailed in the alternative profile pages of the plans as held by the Miracle Association and shown as sections in Appendix 1
An enclosed or open mast gate
Spinnaker chute
False floors, either half or full length conforming to the specified measurements (the central and rear bulkheads may be modified to accommodate these).

- [d] Hull thickness shall be a minimum of 5mm and a maximum of 15 mm on the lower chine panels.
Deck ply shall be a minimum of 4mm.
Battens are optional

All variants are to conform to all the relevant measurement points as detailed on the measurement form revised January 2020 and subsequent revisions.

Rules of the Association
Miracle Association Rules of Measurement and Construction

2. DIMENSIONS

The Measurement Forms contain as many measurements as is considered practical to check the dimensions and shape of all parts of the boat. This does not permit changes to shape at other places.

3. WEIGHT

The weight of the Hull in dry conditions shall not be less than 58kgs.(or 62kgs inc. centreboard) The Hull includes all permanent fixtures and fittings, i.e. fixed by screws, nails, rivets, glue or resin, but no other equipment. Where it is necessary to fit correctors, these shall be weighed by the measurer and fixed permanently to and under the thwart. The weight of the correctors shall be recorded on the Measurement Certificate.

- * The weight of the Rudder and Tiller, Centreboard and spars are not included in the measurement of the Hull Weight.
- * Weighing shall be of single point suspension using scales calibrated to read 0 to 100kg and be certified for accuracy by a competent tester every 5 years.

4. CENTREBOARD, CENTREBOARD CASE, RUDDER AND TILLER

[a] The Centreboard and Rudder blade shall be constructed of plywood, solid wood or glass fibre and resin. Solid wood may be laminated from separate pieces. Each piece shall be the full thickness of the board or blade. Glue lines shall run the length of the board or blade.

[b] Centreboard thickness shall be constant except that the faces may be faired up to 50mm (2") from any edge. The profile of the Centreboard is controlled by the measurements except that the corners may be shaped.

[c] The Centreboard Case shall be constructed so that its sides are parallel.

- * [d] The Rudder Blade shall be pivoted in the Stock. it may be profiled across its full width

[e] The edges of the Centreboard and Rudder may be protected by optional material not exceeding 13mm x 13mm cross section

[f] The Stock, Tiller and Tiller Extension are optional in size and shape, and shall be constructed of wood, metal, or glass fibre and resin, or any combination thereof.

[g] The material to be used for Rudder Gudgeons and Pintles is optional.

[h] Packing of the space between the Centreboard and the Centreboard Case is allowed by means of a piece or pieces of any flat material of uniform thickness applied to the Centreboard in such a manner that it (they) shall not protrude below the keel with the Centreboard in any position. Nor shall the packing piece(s) be less than 75mm (3") radius measured from the centre of the pivot pin.

[i] Packing of the space between the Rudder Blade and the Stock cheeks is allowed by means of a piece or pieces of any flat material of such dimension that they do not extend beyond the design contour of the stock.

Rules of the Association
Miracle Association Rules of Measurement and Construction

5. SPARS

- [a] The Mast and Boom sections shall be constant over their main lengths. The mast shall have a grooved track for the Main Sail luff. The mast must have two contrasting bands not less than 10mm wide painted on it as per the Measurement Form. The Main Sail shall not extend below the top edge of the bottom "Black Band" or above the bottom edge of the top "Black Band".
- [b] The Shroud attachment points and Halyard Sheaves shall be positioned as per the Measurement Instructions.
- [c] Buoyant material may be fitted inside the Mast Tube.
- [d] No other fittings other than the eyes supplied shall be used to locate or attach the kicking strap to the Mast and Boom.
- [e] Authorised fittings may only be attached to the Boom in such a manner as to ensure that they cannot foul the rigging of another boat.
- [f] Spreaders of a rigid type at a recommended height from the mast step of 2670mm, length and deflection angle optional but non adjustable when sailing are permitted.
- [g] Spars may not be constructed of carbon fibre

6. STANDING RIGGING

- [a] One pair of Shrouds to be multi strand wire of 2.5mm minimum nominal diameter.
 - [b] One Forestay to be multi strand wire of 2.0mm minimum nominal diameter.
- Note: rules [a] & [b] – Manufacturers standard max.& min tolerances on nominal diameter is accepted

7. RUNNING RIGGING

Type and material of running rigging are optional.

Rules of the Association
Miracle Association Rules of Measurement and Construction

8. PERMITTED EXCEPTIONS

[a] Two Foresheet Cleats.

b] Centre or transom main sheeting are options on all boats.

The mainsheet must route through a block on the end of the boom and then must be fixed either to a slide or to a bridle on the transom. A block fixed to either of these may be used to achieve a maximum purchase ratio of 3:1

The slide shall be free running in the Mainsheet track and shall have an unrestricted travel of 250mm plus or minus 5mm, (125mm either side of the centreline of the boat and the track) when measured through the centreline of the hole into which the Mainsheet Block is fitted.

Alternatively up to two non-adjustable bridles may be used fixed to the top edge of the transom with the apex of the bridle having a maximum height of 150mm from the transom sheer line and in line with the boats centreline.

For centre main sheeting the maximum purchase ratio remains 3:1 and any block mounted amidships must be on a strengthened pad to the rear of the thwart. The use of this block is optional.

[c] Metal or plastic strip for the protection of chine's or keel may be added part or full length, maximum section 15mm wide, 5mm thick.

[d] Wind direction indicators (non-electric).

[e] One Compass may be fitted to the boat, but the boat must not be cut or altered to mount this, except for the necessary fastenings.

[f] Two self Bailers.

[g] A stick to extend clew of Foresail out on opposite side of boat to the Main Boom; an anchor for the inboard end of this stick may be added to the Mast.

[h] Two protection pads for an Outboard Motor on the Transom.

[i] Using the existing Boom fitting; the ratio of the Kicking Strap is optional. A split Control System with up to two Cleats is allowed.

[j] Shroud and Forestay adjusters. (pin-rack type only).

[k] Adjustable Clew outhaul for the Mainsail which may incorporate a track and slide; all the controls may be run internally and/or externally along the boom and may be led to fittings at any points on the hull, mast or boom.

[l] Maximum of two screw type Ventilation Hatches for each tank - maximum size 152mm diameter (6" dia.).

[m] Fittings for retaining Paddles, Hand Bailers and Anchor.

[n] Two additional Floor Battens similar to those supplied may be fixed to the bottom.

[o] Adjustable Tack Downhaul for Mainsail: control lines may be led to fittings at any points on the hull, mast or boom.

[p] Two single row hook up racks may be fitted to the mast for attaching the Main and jib halyards. These may be in addition to the standard Cleats. The jib may be tensioned by a Highfield Lever.

Rules of the Association
Miracle Association Rules of Measurement and Construction

- [q] i) The standard rope handle for the centreboard may be replaced by a pair of stops bolted together through the existing hole in the handle. No dimension for each stop may exceed 40mm.
- ii) A length of shock cord with or without a rope tail may be attached to the handle of the Centreboard and lead aft to a jamming device to hold the Centreboard in a "down" position.

[r] Toe Straps. The method of attachment of both ends of the toe straps is optional.

[s] A maximum of four open Fairleads, one Sampson Post and one Eye Plate may be fitted on the deck for the purpose of leading and securing an anchor and towing warp in such a way that no fitting extends forward of the Bow or outside the Sheer line.

[t] One wooden Knee may be fixed to each side of the forward end of the Centreboard Case and the skin of the boat, maximum height 180mm, maximum extension from Case 180mm and maximum thickness 16mm.

[u] A triangular block may be fixed in each corner made by the transom and side decking.

[v] Solid wood fillets may be fixed to the forward side of the stowage bulkhead and the floor and chine panels. Maximum sectional dimensions 25mm x 25mm.

[w] Two limit stops may be fixed to the Central Spine to position the foot of the Mast. The position of the Mast shall not be moved whilst racing.

[x] Cosmetic Additions

The Hull of the Miracle may be decorated or aesthetically enhanced only in the following manner:

(a) Standard foredeck, side deck and seat tops may be replaced with 4mm minimum plywood of a different species.

(b) Decks must be securely fixed by gluing, additional pinning is optional.

(c) Decoration of the Hull shall be limited to...

(i) A solid wooden fillet between the foredeck panels 16mm wide maximum and to a maximum thickness of the deck ply fitted so as not to stand proud of the foredeck.

(ii) A solid wood lamination of maximum thickness 6mm and up to the full depth of the bead may be inserted between the Gunwale and the Rubbing Bead Gunwale. (part numbers 3(c) and 35 respectively – Building instruction Manual).

[y] A fitting (such as Holt ref.HA10) may be used to prevent the main Halyard jamming in the track.

[z] Joints may be epoxy filleted instead of glass tape.

[zx} Sheeting angle may be reduced by routing each sheet through a fairlead or block attached to the Seat Coming (Part No 25 on the plans) at a minimum distance of 350 mm from the centre line of the boat and not more than 2325 mm from the aft side of the of the aft transom. These blocks or fairleads may be fixed, or attached to a sliding track mounted on the Seat Comings

Alternatively a floating block or fairlead attached to the forward face of the centreboard case may be used to achieve the same measurement as above.

All measurements are taken to the bearing surface of the fairlead or block

[aa] A tie is permitted between the King Plank and the Spine just forward of the stowage bulkhead.

[ab] A wooden grab rail of optional length may be fitted to the top edge of the side tank sides. The dimensions of the rail shall not be more than 35mm deep x 18mm wide. The rail shall not project above the top of the side tank.

Rules of the Association
Miracle Association Rules of Measurement and Construction

- [ac] The existing Thwart may be joined together across the centre-case by a bridging piece, or be made in one piece. The thwart may be laminated along its major dimensions and may have holes cut in it for fittings or to assist crew purchase during capsize recovery.
- [ae] A rack type mast foot (non-adjustable whilst sailing) is allowed - requires a tennon mast foot - It is recommended that this type of rack mast foot should be fixed to the spine by horizontal screws or bolts - not vertically into the spine end ply.
- [af] The top edge of the aft transom may be curved uniformly between the inside edge of the top decks to a depth at the boat centre line of 55mm+/-5mm.

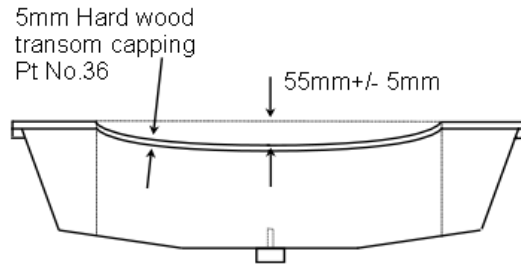

- [ag] The Forestay attachment plate is optional.

9 **PERMITTED HOLES**

The Hull and Spars may not be cut in any way other than that needed to run control lines, affix permitted fittings and toe straps, and for necessary drain holes.

Transom Flaps are permitted and the holes cut in the transom shall have no dimension greater than 140mm. In addition, the hole shall be cut such that no damage shall be caused to the tape Joint between the transom and the bottom and side panels.

Boom - may be lightened at the outer end by tapering the underside to a min. depth of 40mm from the top surface from a point 350 mm from the end of the boom. Three oval lightening holes may be cut out either side, max size 70x20mm.

10 **BUOYANCY**

Buoyancy shall consist of three separate tanks, the efficiency of which shall be determined by the owner. FRP boats may have a single tank plus sufficient positive buoyancy to remain afloat if holed.

N.B delete or ignore all reference to Annual Buoyancy Inspections on current Measurement certificates

Rules of the Association
Miracle Association Rules of Measurement and Construction

11

SAILS

- 1] All new Sails shall comply with the Measurement Form Points of Measurement as defined in World Sailing's "Equipment Rules of Sailing 2017-2020 All Sails shall be measured in a completely flat state and laid on a flat floor with tension adequate to remove all wrinkles along and adjacent to the measurement being taken.
- 2] All Measured Sails shall be dated and signed by a measurer in indelible, waterproof ink. Certified Sail makers (those having produced 5 or more sets previously measured as in class) may provide sails not requiring measurement. These sails to be subject to random checks at the Measurement Secretary's discretion.
- 3] Date and signature to be positioned on the tack reinforcement on the fore and mainsails and on the head reinforcement on the spinnaker.
- 4] Championship sail verification stamp mark to be positioned as the measurer's signature and date.

[A] Mainsail and Foresail

- 1] The Mainsail and Foresail should be of white woven polyester fabric. The Mainsail as an alternative may be made from laminate material reinforced with a polyester weave. Both sails to be edged in red tape.
The red tape may be omitted from the leach of the Foresail
- 2] Class insignia and sail numbers shall be in red.
- 3] The foresail may be fitted with one transparent Panel which shall not exceed 1300 mm in length x 300 mm in height
The Mainsail may be fitted with two transparent panels. one shall not exceed 2500 mm in length and 300 mm. in height. The second shall not exceed 300mm in length and 400mm in height.
- 4] The Mainsail shall have three sail battens positioned so as to divide the leach into four approximately equal parts.
Batten and pocket dimensions and positions to be as determined by the measurement form.
A reinforcing patch of 160mm maximum diameter may be fitted to the inner end of the batten pocket.
- 5] Permanent attachment of the Jib luff to the eye in the luff wire at the head of the sail is optional, but must not be permanently secured to the luff at the eye of the tack.
- 6] Jib hanks are an optional fitting.
- 7] The Jib fairleads may be fixed anywhere in the fairlead pad or on that part of the deck carlin which is rebated into the fairlead pad
- 8] The position of the jib fairlead shall not be more than 2325mm from the aft side of the aft transom and shall not be less than 560mm from the centreline of the boat. Also - see under permitted exceptions [zx]

Rules of the Association
Miracle Association Rules of Measurement and Construction

[B] Spinnaker

- 1) One Spinnaker only shall be carried on board during a race. The same Spinnaker must be used for all races in any Association Event. Replacement Spinnaker at the discretion of the Race Committee.
- 2) The spinnaker shall be symmetrical in form and construction.
- 3) Colours of spinnaker are optional.
- 4) The sail is to be constructed of no more than five seams stretching from luff to luff and one central seam (if required).
- 5) Radial and tri-radial are not allowed.
- 6) The edges of the sail shall be bound with tape.
- 7) Headboards are not permitted, but cloth reinforcing patches are permitted on head and clews.
- 8) Up to two downhaul patches are permitted
- 9) The sail must conform to the measurements as stated in these rules and on the Measurement Form.
- 10) Sail numbers to conform to RYA/ISAF Rules.
- 11) A spinnaker shall be measured folded along its centreline with luffs together lying as flat as possible on the floor with sufficient tension to remove wrinkles.
- 12) The following are specified:
 - (i) Distance from centre of shroud and forestay tang eyes to top of the sheave in block maximum 250mm. (or 220mm maximum from centre of T terminals to top of the sheave)
 - (ii) Only one Spinnaker pole may be used with a maximum overall length of 1525mm
 - (iii) No Spinnaker, Deck or Shroud fittings shall extend beyond a vertical line through the outer edge of the Rubbing bead (i.e. When the system is in normal tension.)
 - (iv) The hull may be cut away for the installation of a spinnaker chute
 - (v) A maximum of two bushed holes of not more than 6mm diameter (10mm diameter max. O/D bush) may be provided in the fore deck to allow control lines to pass through. The holes are to be positioned so that the control lines pass through the mast partners so as to not interfere in any way with the mast partner clamping and fixing screws. The bushes to be of either nylon, brass, stainless steel or other similar material

CLASS INSIGNIA AND SAIL NUMBERS

Rules of the Association
Miracle Association Rules of Measurement and Construction

1. The class insignia and the sail numbers shall be red.
2. The numbers shall have a minimum height of 300mm.
3. The insignia shall conform to the class dimensions illustrated below.



6. ADDITIONAL RULES

1. Only sails endorsed in accordance with the Miracle Rules of Measurement (Sails) shall be used.
2. Not more than one mainsail, one headsail and one spinnaker shall be used at an event. Replacement sails for those damaged whilst racing at an event are at the discretion of the race officers.
3. The mainsail shall be set so that the highest visible point at the head is lower than the lower edge of the upper mast measurement band, the tack shall be set so that the lowest visible point is higher than the top edge of the lower mast measurement band and the aft most visible part of the leech shall be set forward of the inner edge of the boom measurement band.

The measurement bands may be of any contrasting colour and must be permanently marked on the spars.
Plastic adhesive tape is not acceptable

12 REGISTERED NUMBER

Rules of the Association

Miracle Association Rules of Measurement and Construction

- i] The Registered Number for Wooden boats should be cut into the inside face of the aft Transom
On FRP Hulls the Registered Number shall be stamped on a plate attached either to the Transom or the Thwart.
- ii] The Builder's Mark, the "Hull Identification Number" (HIN) and the CE mark are to be stamped or etched on plates and permanently positioned as specified by the National Authorities.
- iii] A builders plate containing all the above may be fitted as an alternative.

13 **MEASUREMENTS**

The Measurements listed with the allowed tolerances shall appear on the Measurement Form. Only a Miracle certified by a recognised Measurer as complying with these rules will be granted a Measurement Certificate. If there is any difference in measurement as per the rules or sketches showing measuring point definitions and the measurement form, the latter should be taken as correct.

14 **ALTERATIONS, MODIFICATIONS, DESIGN & SPECIFICATION CHANGES**

Unless these rules give definite permission for any specific addition, substitution or alteration, it will not be accepted.

15 **MEASURERS**

The following are Measurers acceptable to the Association subject to confirmation of their suitability by the Measurement Secretary:

- a) Approved RYA Measurers
- b) Club Measurers
- c) Measurers approved by the Miracle Association.

Miracle Association
January 2020

Diagram 1

**Rules of the Association
Miracle Association Rules of Measurement and Construction**

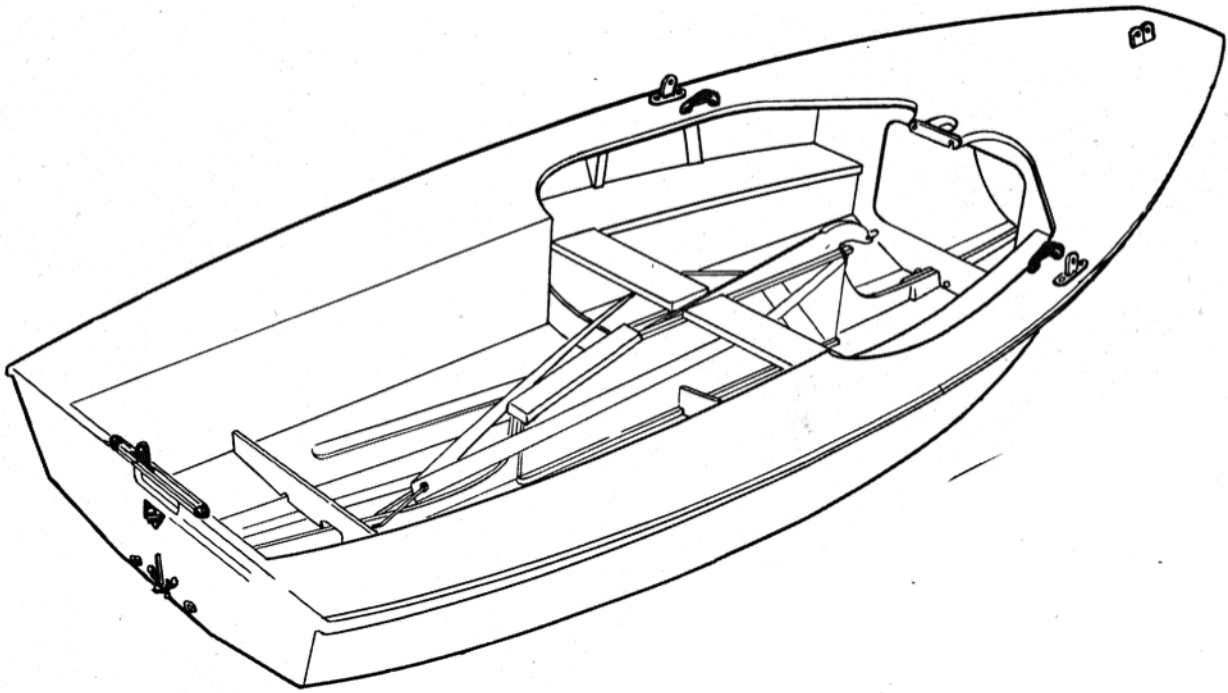
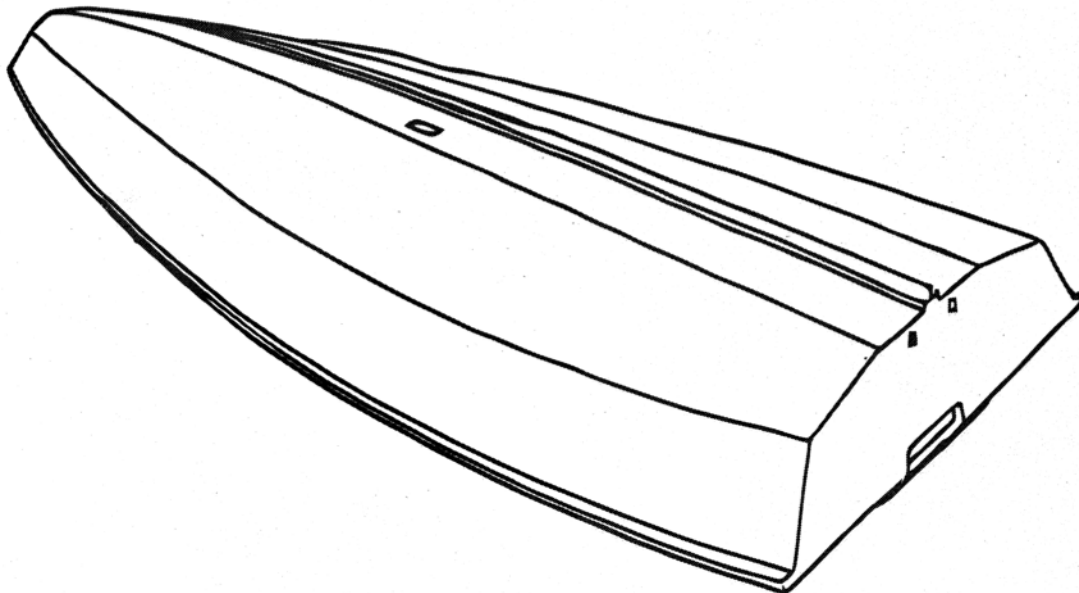

Diagram 2



Appendix 1

Rules of the Association
Miracle Association Rules of Measurement and Construction

